

USER MANUAL

Trimble LOADRITE L3180 SmartScale for loaders

Software 60485
Version 2.1.0
Revision J
April 2021
ENGLISH

109640-95-ENG



Trimble LOADRITE L3180 SmartScale for loaders User Manual

Software Number: 60485

Version Number: 2.1.0

Document Number: 109640-95-ENG

Revision: J

Issued Date: April 2021

E: info@loadritescales.com

W: www.loadritescales.com

© 2021 Trimble Inc. All rights reserved. Trimble, the Globe & Triangle logo are trademarks and/or registered trademarks of Trimble Inc, registered in the United States and in other countries. Loadrite is a trademark and/or registered trademark of Trimble Inc. All other trademarks and registrations are the property of their respective owners.





The software contains proprietary information of Trimble Inc; it is provided under a license agreement containing restrictions on use and disclosure and is also protected by copyright law. Reverse engineering of the software is prohibited.

This document is copyrighted with all rights reserved. Under copyright laws, this document may not be copied in whole or in part, reproduced in any other media, stored in a retrieval system, or transmitted in any form or by any means, electronic, mechanical, photocopying, recording or otherwise, without the express written permission of Trimble Inc. Permitted copies must carry the same proprietary and copyright notices as were affixed to the original. Under the law, copying includes translation into another language.

Published in New Zealand.

Important safety information

PLEASE READ CAREFULLY BEFORE USING THE LOADRITE™ WEIGHING SYSTEM

	This is the safety alert symbol. It is used to alert you to potential personal injury hazards. Obey all safety messages that follow this symbol to avoid possible injury or death.
	WARNING indicates a potentially hazardous situation which, if not avoided, could result in death or serious injury.
	CAUTION indicates a potentially hazardous situation which, if not avoided, may result in minor or moderate injury.
	CAUTION used without the safety alert symbol indicates a potentially hazardous situation which, if not avoided, may result in property damage.



It is your sole responsibility to place, secure and use the LOADRITE Weighing System in a manner that will not cause accidents, personal injury or property damage. Always observe safe operating practices.

Do not install the LOADRITE Weighing System in a way that may interfere with the safe operation of the vehicle, or deployment of safety equipment.

Before you use the LOADRITE Weighing System for the first time, familiarize yourself with the system and its operation.



Do not handle any part of the LOADRITE Weighing System if it is hot. Let the product cool, out of direct sunlight.

Ensure that the LOADRITE Weighing System is connected to a power source with the correct fitting and voltage requirements.

Do not attempt to service the LOADRITE Weighing System as this could result in personal injury.



Removing LOADRITE Weighing System equipment or adding accessories could affect the accuracy of weighing data and your warranty.

Do not install cables over horizontal surfaces where they may be stood on or hit by falling objects.

Failure to adhere to these warnings and cautions may lead to death, serious injury or property damage. Trimble Inc disclaims all liability for installation or use of the LOADRITE Weighing System that causes or contributes to death, injury or property damage, or that violates any law.

Table of contents

1.0 Welcome	5
2.0 Introduction	6
2.1 LOADRITE equipped loader	7
2.2 Front features	8
2.3 Rear features	10
2.4 Total screen	12
2.5 Accurate weighing	14
2.5.1 Obtaining the best weighing results	14
2.5.2 Legal for Trade systems	14
3.0 The day-to-day weighing process	15
3.1 How do I turn on the Indicator?	15
3.2 How do I perform a warm-up?	15
3.3 How do I select a scale?	16
3.4 How do I zero the empty bucket?	17
3.5 How do I select a product to weigh?	18
3.6 How do I select a customer?	19
3.7 How do I weigh and add a bucketload?	20
3.7.1 Remote Buttons	21
3.7.2 What is Auto-Add?	21
3.7.3 Undo/Redo	22
3.8 How do I finish the load?	23
3.9 How do I put the Indicator into Standby mode?	23
3.10 How do I turn off the Indicator?	23
4.0 Customizable data lists	24
4.1 Select a data list value	24
4.2 Add a new data list value	25
4.3 Delete a data list value	26
4.4 Suspend data lists	27
5.0 Target Weighing mode	28
5.1 How do I enter Target Weighing mode and input a target?	28
5.2 How do I return to Total mode?	30
6.0 Split Weighing mode	31
6.1 Using Split Weighing mode within Total mode	31
6.2 Using Split Weighing mode within Target Weighing mode	32
7.0 Main Menu	33
7.1 Product (Data List 1)	34
7.2 Customer (Data List 2)	35

7.3	Truck (Data List 3)	35
7.4	Data List 4 to Data List 9	35
7.5	History	36
7.5.1	Search for a ticket	36
7.5.2	Print a ticket	37
7.6	Scale	37
7.7	Reprint	38
7.8	Clear All	38
7.9	Metrics	38
7.9.1	Operator Metrics	38
7.9.2	Totals	39
7.9.3	Reset Metrics	39
7.10	Preferences	40
7.10.1	Auto-Add	40
7.10.2	Data Suspend	40
7.10.3	Data List Display	41
7.10.4	Brightness	42
7.10.5	Remote Buttons	42
7.10.6	Enable Beeper	42
7.10.7	Date and Time	43
7.10.8	Language	44
7.11	About	44
7.12	Setup...	44
8.0	Appendix A: System specifications	45
8.1	Weighing accuracy	45
8.2	Minimal weighing delay	45
8.3	Power requirements	45
8.4	Physical specifications	45
8.5	Environmental specifications	46
8.6	Electrical specifications	46
9.0	Appendix B: Span calibration adjustment	47
9.1	Checking the adjustment	48
10.0	Appendix C: Legal information	49

1.0 Welcome

Thank-you for purchasing this LOADRITE Weighing System. Please read this manual carefully before using the Indicator for the first time. Keep this manual in a safe place and use as your first point of reference.

Formatting

The following formatting in this manual identifies specific types of information:

Convention	Type of Information
Bold	<ul style="list-style-type: none"> ■ Indicates a button on the Indicator, or ■ Indicates an area displayed on-screen, including buttons, headings, field names and options.
<i>Italics</i>	<ul style="list-style-type: none"> ■ Indicates the name of a screen or window, or ■ Indicates an operation mode that the Indicator can be set to.
Monospace	The exact error message displayed on-screen.

Action Terms

The following terms are used throughout this manual to describe actions:

Term	Description
Press	<p>Physical buttons: Push and release a button.</p> <p>On-screen buttons: Tap the screen icon (or press the function button directly under the on-screen button).</p>
Tap	Press and release a button, menu option or other item on the touchscreen.
Select	<ul style="list-style-type: none"> ■ Tap the button, menu option or other item on the touchscreen, or ■ Press the function buttons directly under the arrow on-screen buttons to "highlight" an item in a menu or list, or ■ Press the keypad number that corresponds with the number in the menu option.

2.0 Introduction

The LOADRITE weighing system measures the weight of loads lifted by wheel loaders, forklift trucks and similar machines that use hydraulic rams to lift the load. The main parts of the LOADRITE Weighing System are:

- the Indicator installed in the cab of the loader, and
- the connected sensors installed on the lifting arms.

As a load is lifted, the angle sensors and hydraulic pressure transducers send information to the LOADRITE Indicator. This information is converted into a digital weight reading that is displayed on the LOADRITE Indicator.

The LOADRITE Indicator is the main user interface with the LOADRITE Weighing System. It has an internal memory that stores settings and production data even when it is turned off.



2.1 LOADRITE equipped loader

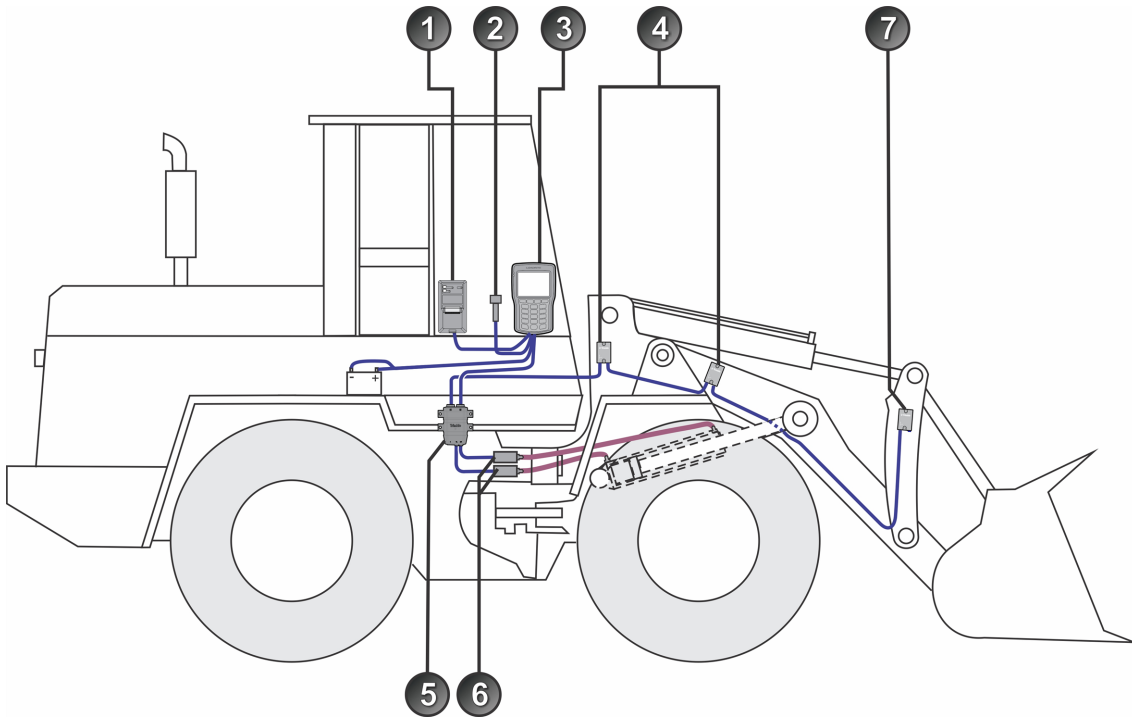



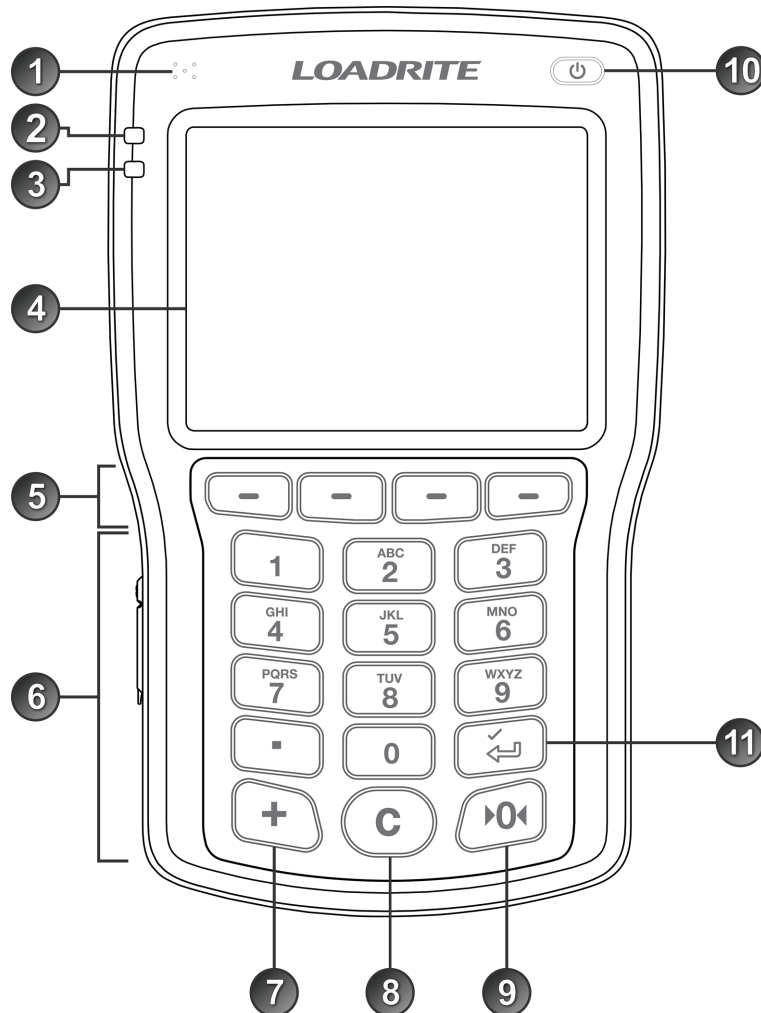

Item	Description
1	Printer (optional)
2	Remote Add Button (optional)
3	LOADRITE Indicator
4	2x Angle Sensors
5	Pressure Transducer Interface (PTI)
6	2x Pressure Transducers
7	Bucket Position Sensor (optional; may be required for Legal For Trade systems)

2.2 Front features





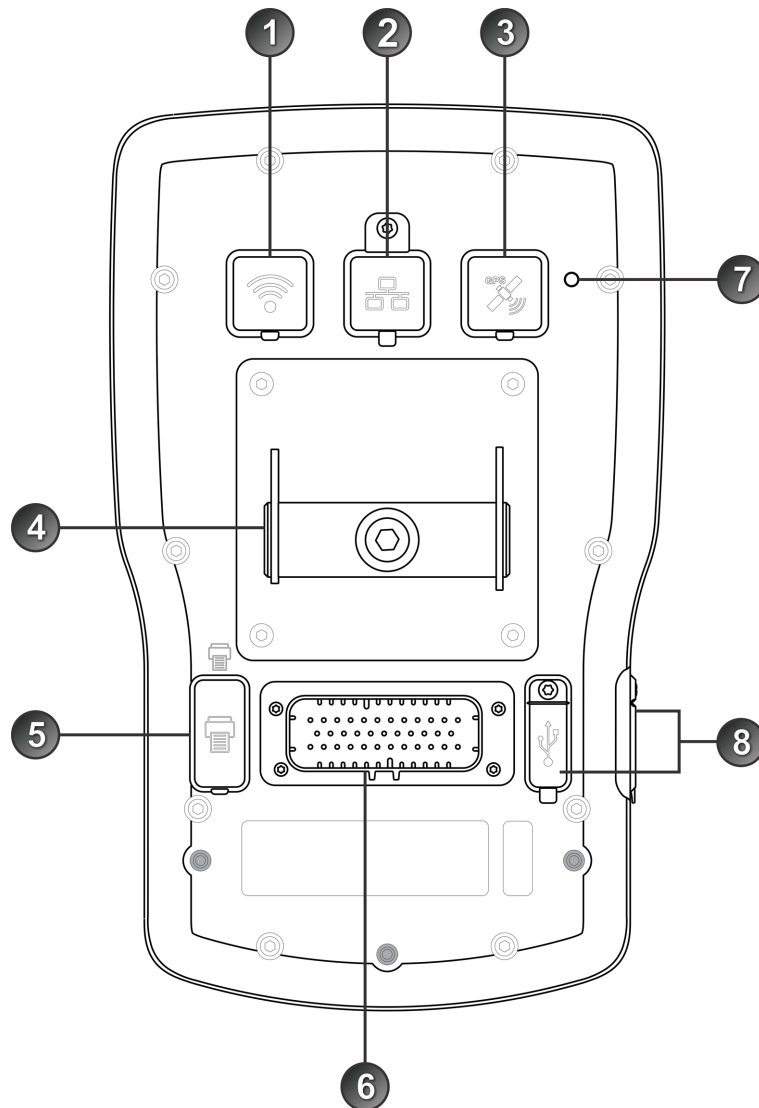

Item	Name	Description
1	Speaker	Broadcasts buzzer and other sounds.
2	Blue light	When lit, indicates that the Indicator has successfully weighed a bucketload of product.
3	Green light	<ul style="list-style-type: none"> ■ When lit, indicates that the bucket is below the Weighing Zone and the Indicator is ready to weigh. ■ When flashing, indicates that the bucket is in the Weighing Zone. ■ When off, indicates that the bucket is above the Weighing Zone.

Item	Name	Description
4	Touchscreen	<ul style="list-style-type: none"> Displays weighing information and menu options. Tap to select on-screen buttons and menu options.
5	Function buttons/ Soft keys	Press to select the corresponding on-screen button.
6	Keypad	Used to enter numbers, characters, symbols and commands.
7		<ul style="list-style-type: none"> Adds the current bucketload to the total. Press and hold to toggle <i>Auto-Add</i> on or off (depending on configuration)
8		<ul style="list-style-type: none"> Clears the short total for the current product. When the <i>Product Data List</i> screen is displayed, press and hold to clear all running totals. Used as a <i>Backspace</i> to delete the previous character when entering text. Used to delete an access code, when entering a code on the <i>Security Code</i> screen.
9		Zeroes the empty bucket.
10		<ul style="list-style-type: none"> When the <i>Total</i> screen is displayed, press to enter <i>Standby</i> mode. When in <i>Standby</i> mode, press to exit <i>Standby</i> mode.
11		<ul style="list-style-type: none"> Selects a menu option or other item. Accepts changes.

2.3 Rear features



Item	Name	Description
1		<p>Connection socket for a wireless network antenna. Remove the rubber bung to access.</p> <div style="border: 1px solid orange; padding: 5px; margin: 5px 0;"> <p>CAUTION – The Indicator must be turned off when connecting or disconnecting an antenna.</p> </div> <div style="border: 1px solid blue; padding: 5px; margin: 5px 0;"> <p>NOTE – Ensure that the rubber bung is replaced when not in use so that the environmental integrity of the Indicator is maintained.</p> </div>

Item	Name	Description
2		<p>Connection socket for an Ethernet network cable. Lift the rubber bung to access.</p> <p>NOTE – Ensure that the rubber bung is replaced when not in use so that the environmental integrity of the Indicator is maintained.</p>
3		<p>Connection socket for a GPS antenna. Remove the rubber bung to access.</p> <p>CAUTION – The Indicator must be turned off when connecting or disconnecting an antenna.</p> <p>NOTE – Ensure that the rubber bung is replaced when not in use so that the environmental integrity of the Indicator is maintained.</p>
4	Mounting bracket	Bracket for mounting the Indicator in a loader.
5		<p>This socket is not used.</p> <p>CAUTION – Do not connect a printer or any other device to this socket as there is a risk of property damage.</p> <p>NOTE – Ensure that the rubber bung is kept in place so that the environmental integrity of the Indicator is maintained.</p>
6	Cable	Connection socket for the POWER CONTROL cable.
7	Light sensor	This sensor is not used.
8		<p>Two USB 2.0 sockets. Lift the rubber bung to access.</p> <p>NOTE – Ensure that the rubber bung is replaced when not in use so that the environmental integrity of the Indicator is maintained.</p>







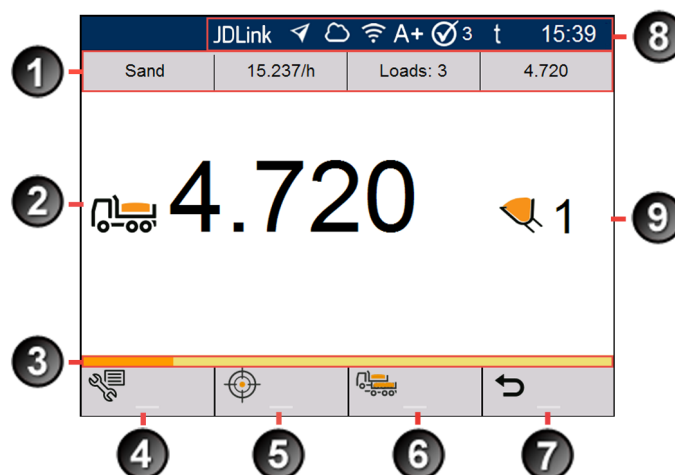

2.4 Total screen

The *Total* screen is the first screen that you will see when you turn on the Indicator.

From this screen, you can weigh a bucketload, undo a bucketload, access the *Main Menu*, and switch to *Target Weighing* mode or *Split Weighing* mode.

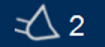

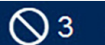
Item	Name	Description
1	Data List Display	Displays the current value of the four (4) customizable data list fields. <ul style="list-style-type: none"> To quickly change a data list value (such as the product), tap the value to display the corresponding data list screen. To change the scale being used, tap the value to display the <i>Scale</i> screen. To view full metrics, tap a metric value to display the <i>Daily Operator Metrics</i> screen. To configure the Data List Display, see <i>Data List Display</i> on page 41.
2	Short total	The current short total of product that has been loaded. <div style="border: 1px solid green; padding: 5px; margin-top: 10px;"> <p>TIP – Depending on the workflow that has been selected at installation, each product may have its own short total, and changing the product will also change the short total that is displayed on the <i>Total</i> screen.</p> </div>
3	Weighing progress bar	Indicates the position of the boom while weighing a bucketload, by changing color from gold to orange.
4	Main Menu	Displays the <i>Main Menu</i> . <ul style="list-style-type: none"> For more information, see <i>Main Menu</i> on page 33.
5	Target weighing	Activates <i>Target Weighing</i> mode. <ul style="list-style-type: none"> For more information, see <i>Target Weighing mode</i> on page 28.

Item	Name	Description
6	Split weighing	<p>Activates <i>Split Weighing</i> mode.</p> <ul style="list-style-type: none"> For more information, see <i>Split Weighing mode</i> on page 31.
7	Undo	<p>Undoes the previous bucketload or discarded weight.</p> <ul style="list-style-type: none"> For more information, see <i>Undo/Redo</i> on page 22.
8	Notification bar	<p>The following icons may display in the Notification bar, depending on the options selected at installation:</p> <div style="display: flex; justify-content: space-between;"> <div style="width: 30%;">           </div> <div style="width: 65%;"> <p>JDLink connection status</p> <ul style="list-style-type: none"> White: Connected to the John Deere™ loader on-board system Gray: Not connected No icon: The connection is disabled. <p>GPS status</p> <ul style="list-style-type: none"> White: A GPS fix has been obtained Gray: No GPS fix. <p>InsightHQ connection status</p> <ul style="list-style-type: none"> White: Connected to InsightHQ Gray: Not connected No icon: The connection is disabled. <p>WiFi connection status</p> <ul style="list-style-type: none"> White: Connected to network via WiFi Gray: Not connected <p>Auto-Add status</p> <ul style="list-style-type: none"> White: Auto-Add is enabled Gray: Auto-Add is disabled No icon: Auto-Add functionality is not available. <p>Scale number</p> <ul style="list-style-type: none"> White: The scale number selected No icon: Only one scale is configured and calibrated. <p>Legal For Trade certification</p> <ul style="list-style-type: none"> Tick: The system is currently certified, and the scale number selected No tick: The system is currently <i>not</i> certified, and the scale number selected. <p>Unit of measurement</p> <ul style="list-style-type: none"> kg: kilograms lb: pounds t: tons or tonnes <p>Current time</p> </div> </div>
9	Bucketloads	The number of bucketloads that have been added to the short total.

2.5 Accurate weighing

For maximum accuracy, ensure that:

- Check Zero is performed regularly.
- Load lifting motion is steady and smooth, with no acceleration or bounce.
- The bucket is fully rolled back during the lift.
- The loader is on level ground.
- The correct scale has been selected.

2.5.1 Obtaining the best weighing results

Lifting speed

For best results, operate the lift lever before accelerating the engine so that the machine does not rock as it lifts, i.e. use normal revs.

Weighing Zone

Start the lift well below the Weighing Zone. This ensures that all acceleration and load bounce has been eliminated well before the weighing sequence begins.

NOTE – We recommend that there are at least two seconds of lift before entering the Weighing Zone.

Bounce

Most loaders have pneumatic tires which can cause the machine to bounce when lifting.

To minimize the effect of bounce, always operate the lift lever before accelerating the engine and start the lift well below the Weighing Zone.

Center of gravity

The hydraulic pressure in the lifting cylinders depends on where the center of gravity of the load is. It is important that the bucket is always in the same position: fully rolled back.

2.5.2 Legal for Trade systems

LOADRITE systems meet Legal for Trade requirements in certain countries. This enables material to be weighed and sold directly from the loader.

For more information or to enquire if Legal for Trade is available in your country, contact your LOADRITE distributor.



TIP – Operating requirements for Legal for Trade systems are detailed in this manual where they differ from standard operating requirements.

3.0 The day-to-day weighing process

The following is the basic process for day-to-day weighing with the LOADRITE Weighing System:

1. Turn on the Indicator .
2. Perform the required warm-up lifts.
3. Select the scale that is attached to the loader.
4. Zero the empty bucket.
5. Select a product to weigh (optional).
6. Select the customer associated with the product (optional).
7. Weigh and add each bucketload.
8. When you have finished loading the truck, clear the short total. If a printer is connected, the loader's totals will be printed and payload data will be sent to InsightHQ.
9. When you have finished using the LOADRITE Weighing System, put the Indicator into *Standby* mode.

3.1 How do I turn on the Indicator?

The LOADRITE Indicator will turn on automatically when you start the loader.

NOTE – Depending on the configuration at installation, you may be prompted to select a value for each data list.

3.2 How do I perform a warm-up?

For best weighing accuracy, the hydraulic fluid in the lift cylinders should be at normal operating temperature. This is achieved by raising and lowering the empty bucket.

i Warm Up Lift 3

The above message will display if the Indicator has been turned off for more than one hour. If you see the above message, you need to raise and then lower the empty bucket past the Weighing Zone three (3) times (the default number of warm-up lifts is three, but it may be set between 1 - 99 lifts at your site):

1. Raise the bucket past the Weighing Zone.
2. Lower the bucket past the Weighing Zone.
3. Repeat two more times until the message disappears.
When the warm-up has completed, the *Total* screen will display.



3.3 How do I select a scale?

NOTE – This step does not need to be completed if there is only one scale available. A scale only needs to be selected if more than one scales are configured.

1. Ensure that the *Total* screen is displayed.
2. Complete one of the following:

Option 1 - Main Menu

NOTE – The **Scale** option is only available on the *Main Menu* if multiple scales have been configured at installation.



- a. Press .
The *Main Menu* will display.
- b. Select **Scale**, then press .
The *Scale* screen will display.

Option 2 - Data List Display

NOTE – Only available if **Scale** has been selected to display in the **Data List Display** bar.

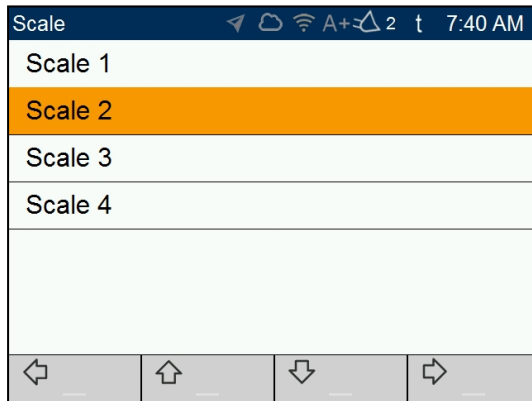
- a. Tap the scale from the **Data List Display** area.
The *Scale* screen will display.



3. Press  or  to scroll up or down the list of scales, then press .
The *Main Menu* will display. All bucketloads will be recorded as having been lifted using the selected scale until a different scale is selected.

IMPORTANT – **Legal For Trade systems:** Ensure that the **Legal For Trade** “tick” icon is displaying in the **Notification Bar** before continuing.

3.4 How do I zero the empty bucket?

The **Check Zero** functionality is only available if selected at installation.

It is necessary to periodically "zero" the bucket because small errors can occur due to a build-up of material in the bucket.

 Check Zero

If you see the above message, you need to zero the empty bucket. The message will display every 15 minutes (the default period is 15 minutes, but it may be set between 1 - 9999 minutes at your site).

IMPORTANT – Legal For Trade systems: You must zero the bucket before beginning a new load.

IMPORTANT – When zeroing the Indicator, the bucket must be empty and kept fully-rolled back.

Complete the following to zero the bucket:

1. Ensure that the loader is level and the bucket is empty.
2. Raise the empty bucket.
3. Press .

The **Zero Updated** message will display, before the *Total* screen is displayed.

3.5 How do I select a product to weigh?

You can only select a product if the Product Data List has been configured and enabled at installation.

NOTE – If your Indicator is configured to use *Data Prompt* functionality, then after selecting an item, you will be prompted to also select from all other Data Lists that follow.

It is important to ensure that the correct product is chosen before you begin to weigh it. Complete the following to select the product:

1. Ensure that the *Total* screen is displayed.
2. Complete one of the following:

Option 1 - Main Menu



- a. Press .
The *Main Menu* will display.
- b. Select **Product**, then press .
The *Product* screen will display.

Option 2 - Data List Display

NOTE – Only available if the Product Data List has been selected to display in the **Data List Display** bar.

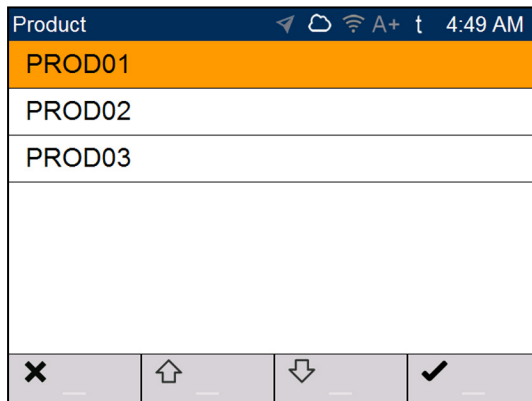
- a. Tap the **Product** data list value from the **Data List Display** area.
The *Product* screen will display.



3. Press  or  to scroll up or down the list of products, then press .
The Indicator will beep and the *Main Menu* will display. All bucketloads will be recorded as the selected Product until a different Product is selected.



TIP – Depending on the workflow that has been selected at installation, each product may have its own short total, and changing the product will also change the short total that is displayed on the *Total* screen.



3.6 How do I select a customer?

You can only select a customer if the Customer Data List has been configured and enabled at installation.

NOTE – If your Indicator is configured to use *Data Prompt* functionality, then after selecting an item, you will be prompted to also select from all other Data Lists that follow.

1. Ensure that the *Total* screen is displayed.
2. Complete one of the following:

Option 1 - Main Menu	Option 2 - Data List Display
<ol style="list-style-type: none"> a. Press . The <i>Main Menu</i> will display. b. Select Customer, then press . The <i>Customer</i> screen will display. 	<p>NOTE – Only available if the Customer Data List has been selected to display in the Data List Display bar.</p> <ol style="list-style-type: none"> a. Tap the Customer data list value from the Data List Display area. The <i>Customer</i> screen will display.

3. Press  or  to scroll up or down the list of customers, then press . The Indicator will beep and the *Main Menu* will display. All bucketloads will be assigned to the selected customer until a different customer is selected.

3.7 How do I weigh and add a bucketload?

When the *Total* screen is displayed, bucketloads can be weighed.

1. Ensure that the **Green light** is lit, which means that the bucket is below the Weighing Zone and the Indicator is ready to weigh.
2. While keeping the bucket fully-rolled back, raise a bucketload of product smoothly through the Weighing Zone using constant engine revs.

IMPORTANT – Legal For Trade systems: You must keep the bucket fully-rolled back while lifting a bucketload, or a **Bucket not emptied** message will be displayed, and the bucketload will not be recorded.

The **Green light** will flash during the lift. If *Weight Preview* functionality is enabled, a preview of the weight will display during the lift:

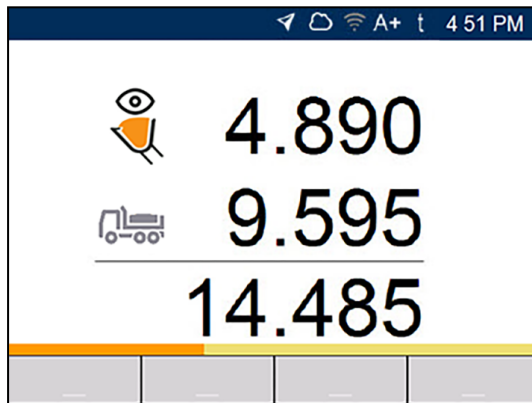

3. When the bucketload has been weighed, the Indicator will beep, the **Blue light** will illuminate, the message **Weighing Complete** will display, and then the *Live Weight* screen will display the following:
 - the current bucketload weight,
 - the weight of the short total,
 - the new short total if the bucketload is added.

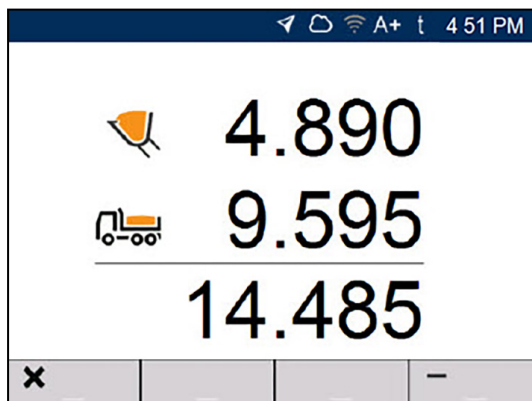

4. Press  to add the bucketload to the short total.

NOTE – If  is not pressed within 8 (eight) seconds of the load being lifted past the Weighing Zone, the Indicator will beep and the **Weight Discarded** message will display. The weight will then be discarded and the *Total* screen will display.

When the load has been added, the *Total* screen will display with the new short total and the number of added bucketloads.

5. Empty the bucketload in to the truck.

IMPORTANT – Legal For Trade systems: Depending on your region, you may need to keep the bucket fully-rolled forward when emptying, or the bucketload will not be recorded.

3.7.1 Remote Buttons

The LOADRITE weighing system supports optional remote buttons. Remote buttons are positioned for your convenience, such as on or near the lift lever, or wired into the horn.

Depending on configuration, pressing a remote button may add a bucketload, clear the total, zero the bucket, or split the load.

Remote buttons can be used interchangeably with the standard buttons on the Indicator.

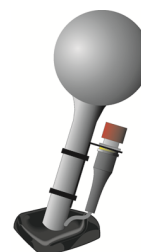

3.7.2 What is Auto-Add?

The *Auto-Add* functionality is only available if enabled at installation.

The *LOADRITE* weighing system can be set to automatically add a bucketload when lifted past the Weighing Zone for a specified number of seconds. This means that you don't need to press  after lifting each load. If *Auto-Add* is enabled, an icon will display on the *Total* screen.

The following may apply depending on how *Auto-Add* functionality was configured at installation:

- Bucket loads may not be added if under a specified amount
- *Auto-Add* may be turned on or off (toggled) via the **Preferences** option on the *Main Menu*, or by pressing-and-holding  from the *Total* screen.

3.7.2.1 Auto-Add toggle

The *Auto-Add toggle* functionality may or may not be available depending on the configuration of your Indicator.



You can toggle between using *Auto-Add* or manually adding lifted weights by pressing-and-holding  from the *Total* screen, or by completing the following:

1. When the *Total* screen is displayed, press . The *Main Menu* screen will display.

2. Select *Preferences*.
3. Select *Auto-Add*.
Auto-Add will be turned **On** or **Off**.

3.7.3 Undo/Redo

The *Undo* function allows you to correct mistakes by “undoing” the previous bucketload and removing it from the Short Total. You can then “redo” the bucketload if you need to, in effect toggling between “undo” and “redo”.

You can also “undo” a discarded weight. For example, if you lift a bucketload but take more than 8 seconds to press , the weight will be discarded; but if you then press , the *Live Weight* screen will reappear and you will have the option to add the weight again.

3.7.3.1 Undoing a bucketload

To *undo* the previous bucketload, complete the following:

- Press .
The message **Undoing previous action** will display, then the *Total* screen will display a new short total that doesn't include the previous bucketload.

Redoing a bucketload

To *redo* the undone bucketload, complete the following:

- Press  again.
The message **Undoing previous action** will display, then the *Total* screen will display a new short total that includes the previous bucketload.

You can continue to press  to toggle between undoing and redoing the bucketload.

3.7.3.2 Undoing a discarded weight

After the **Discarded Weight** message has displayed, the *Total* screen will display. To *undo* the discarded weight, complete the following:

1. Press .
The discarded weight is canceled and the *Live Weight* screen will display the following:
 - the current bucketload weight,
 - the weight of the short total,
 - the new short total if the bucketload is added.

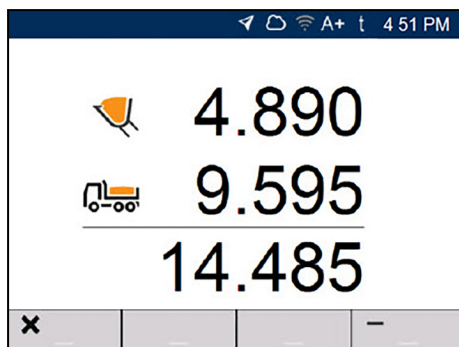

2. Press  to add the bucketload to the short total.

3.8 How do I finish the load?

When you have finished adding bucketloads to the truck, you must clear the short total.

To clear the short total, complete the following:

- Press .

The short total will display briefly, followed by the **Total Cleared** message, then the *Total* screen.

Depending on the configuration at installation, the following may happen:

- weighing data is sent to InsightHQ,
- one or more tickets are printed,
- you are prompted to select a value for each data list.

IMPORTANT – Legal For Trade systems: You must zero the bucket before beginning a new load.

3.9 How do I put the Indicator into *Standby* mode?

If you are not going to use the LOADRITE Weighing System for a while, you can put the Indicator into *Standby* mode by completing the following:

- When the *Total* screen is displayed, press .
- The Indicator will enter *Standby* mode and the time and date will display.

How do I exit *Standby* mode?

- Press any button to exit *Standby* mode.
The *Total* screen will display.

3.10 How do I turn off the Indicator?

The LOADRITE Indicator will turn off automatically when you turn off the loader.

4.0 Customizable data lists

The *Customizable Data Lists* functionality is only available if selected at installation. For information on configuring data lists, refer to the *LOADRITE InsightHQ Configuration Manual*.

Your Indicator has nine customizable data lists that are used to record information against each weight to help track and monitor weighing data. For example, data lists may be configured to record a customer, truck type, or truck ID, against the weight data. The data can then be transferred to InsightHQ via a Wi-Fi network and/or printed along with the weight data.

4.1 Select a data list value

Data field values, such as Product, Truck, Customer, etc., can be changed before starting a new load. The following example assumes that **Data 1** represents available products to weigh, and shows how to select a product to record against the weighing data.

NOTE – If your Indicator is configured to use *Data Prompt* functionality, then after selecting an item, you will be prompted to also select from all other Data Lists that follow.

1. Ensure that the *Total* screen is displayed.
2. Complete one of the following:

Option 1 - Main Menu



- a. Press .
The *Main Menu* will display.
- b. Select **Product**, then press .

Option 2 - Data List Display

NOTE – Only available if the Product Data List has been selected to display in the **Data List Display** bar.

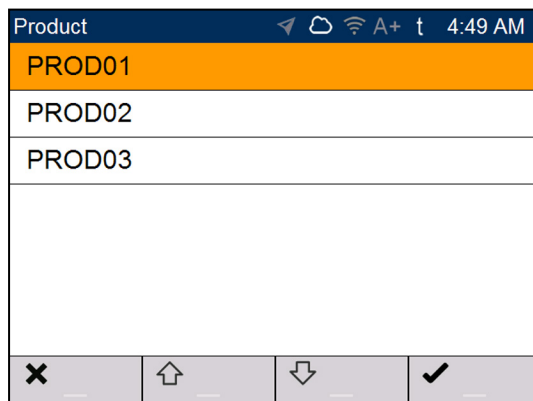
- a. Tap the **Product** data list value from the **Data List Display** area.
The *Product* screen will display.



3. Press  or  to scroll up or down the list of products, then press .
- The Indicator will beep and the *Main Menu* will display. All bucketloads will be recorded as the selected Product until a different Product is selected.



4.2 Add a new data list value

New values can only be added to a Data List that has been configured to allow them.



If the data list value that you need is not in the data list, then you can add the value using the keypad.

NOTE – Data field values can only be entered using specific *Western Latin* characters, such as in English.

The following example shows how to add a new product to the data list.

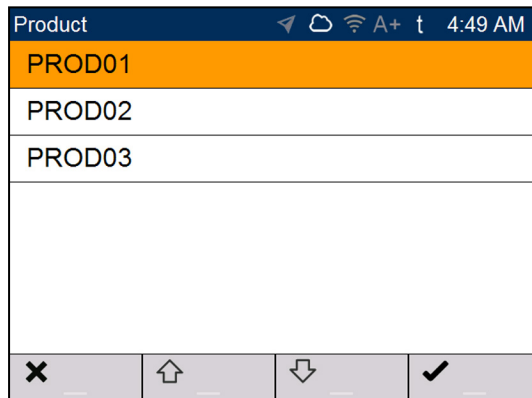
1. Ensure the *Total* screen is displayed.
2. Press .
The *Main Menu* will display.
3. Select **Product**, then press .
The *Product* screen will display.



4. Press .
The *Enter new Data Item* screen will display.
5. Use the keypad to enter the name of the value, then press .
The *Product* screen will re-display with the new value at the bottom of the list. The new value will be automatically assigned to the next load.



IMPORTANT – For sites that synchronize data using InsightHQ, the new data field value may be deleted from the Indicator if it is not assigned to a load before the next synchronization. Therefore it is best practice to create a new data field value just prior to it being used for a load, rather than creating multiple data field values in advance.

4.3 Delete a data list value



Data List values can only be deleted if the Data List that has been configured to allow it.

You can delete data list value that is no longer required. The following example shows how to delete a product from the data list.

IMPORTANT – For sites that synchronize data using InsightHQ, a deleted data field may reappear on the Indicator during the next synchronization. Therefore it is best practice to delete data field values from InsightHQ, rather than from the Indicator.

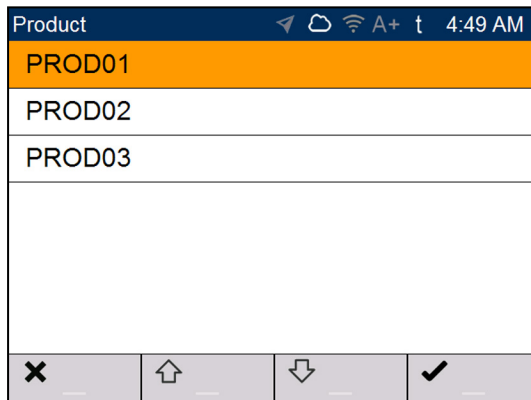
1. Ensure the *Total* screen is displayed.
2. Press .
The *Main Menu* will display.
3. Select **Product**, then press .
The *Product* screen will display.



4. Press .
The message **Are you sure you want to delete?** will display.
5. Press .
The *Product* screen will re-display with the deleted value removed from the list.

NOTE – If you delete a data list value that is currently selected for weighing, it will continue to remain selected until a different value is selected.

4.4 Suspend data lists

The *Data Suspend* functionality is only available if enabled at installation.



Data Suspend is a feature that allows you to temporarily suspend associating data list values with loads. This is useful if a loader operator is training.

If *Data Suspend* is enabled, the Indicator will:

- stop sending data list values to InsightHQ,
- stop printing data list values on tickets.

NOTE – *Data Suspend* cannot be enabled for **Data 1** (Product).

Complete the following to suspend or resume data:

1. Ensure the *Total* screen is displayed.
2. Press  .
The *Main Menu* will display.
3. Select **Preferences**, then press  .
The *Preferences Menu* will display.
4. Select **Data Suspend**, then press  .
The *Data Suspend* function will be enabled or disabled.

NOTE – *Data Suspend* will be disabled if a Data List value is selected.

5.0 Target Weighing mode

Target Weighing mode is only available if enabled at installation.

Target Weighing mode provides a simple way to load a truck to a predefined target weight using a series of bucketloads. It is typically used when loading a truck to its optimum payload.

Before loading, enter a target weight value. Each time a bucketload is added, the target value is reduced by that amount.

- For using *Target Weighing* with multiple vehicle units (such as truck and trailer), see "*Using Split Weighing mode within Target Weighing mode*" on page 32.



5.1 How do I enter *Target Weighing* mode and input a target?

- Press  to clear the previous short total.

IMPORTANT – Legal For Trade systems: You must zero the bucket before beginning a new load.

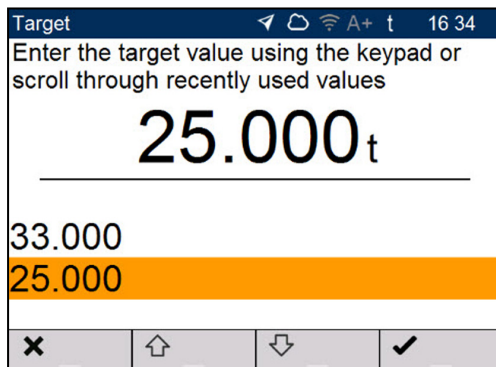
- Press . The *Target* screen will display.



- Use the keypad to enter the target weight value, or use  and  to select a previous target weight value, if available.

4. Press .
The *Total* screen will display in *Target Weighing* mode.

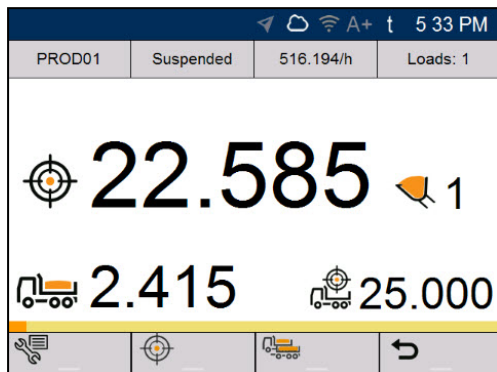

5. Raise a bucketload of product through the Weighing Zone using constant engine revs.
The **Green light** will flash during the lift. If *Weight Preview* functionality is enabled, a preview of the weight will display during the lift:

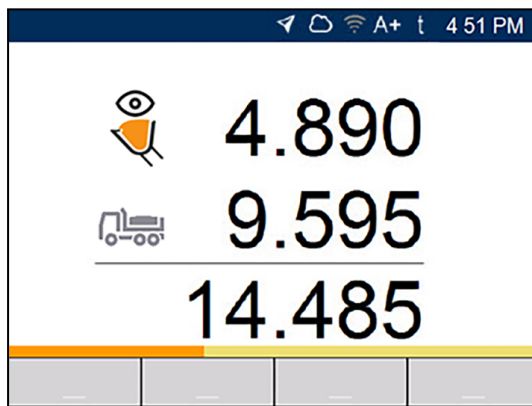

6. When the bucketload has been weighed, the Indicator will beep, the **Blue light** will illuminate, the message **Weighing Complete** will display, and then the *Live Weight* screen will display the following:
- the target weight,
 - the current bucketload,
 - the new target weight, if the bucketload is added to the truck.

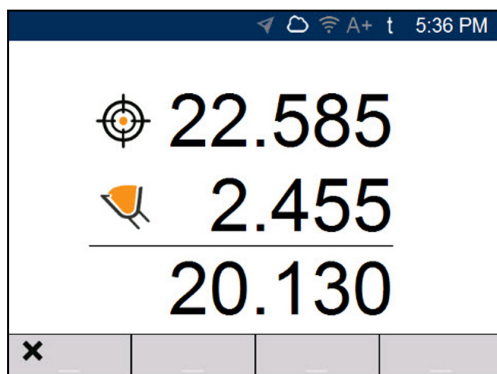



7. Press  to add the bucketload to the truck.
8. Empty the bucketload in to the truck.

- Repeat steps 5-8 until the target weight is as close to **0** (zero) as possible.

IMPORTANT – Legal For Trade systems: You must zero the bucket before beginning a new load.

5.2 How do I return to *Total* mode?

To return to *Total* mode from *Target Weighing* mode, the target must be set to **0** (zero).

- Press .
- Use the keypad to enter a target weight value of **0**, then press .
The *Total* screen will display.

6.0 Split Weighing mode

Split Weighing mode is only available if enabled at installation, and the Loadout Workflow mode is enabled.

Split Weighing mode splits the total weight into multiple sub-totals, providing an easy way to load train wagons, or a truck and trailer. *Split Weighing* mode is also used to track load distribution over a single vehicle unit, to avoid overloading an axle.

Split Weighing mode can be used in conjunction with *Total* or *Target Weighing* modes.

Example

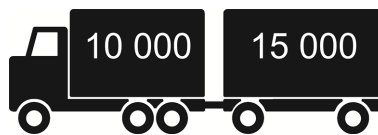



A truck with a trailer requires loading. The truck can carry 10,000 tonnes and the trailer 15,000 tonnes, making a total of 25,000 tonnes. First load the truck, then use *Split Weighing* mode to load the trailer.

6.1 Using *Split Weighing* mode within *Total* mode

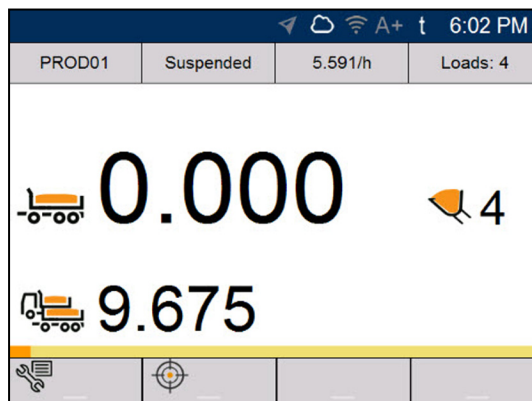

1. In *Total* mode, load the truck with the required amount or product.
2. When the required amount of product for the truck is reached, press .

The *Total* screen will display in *Split Weighing* mode. The grand total of the entire vehicle is shown, along with the short total for the trailer.





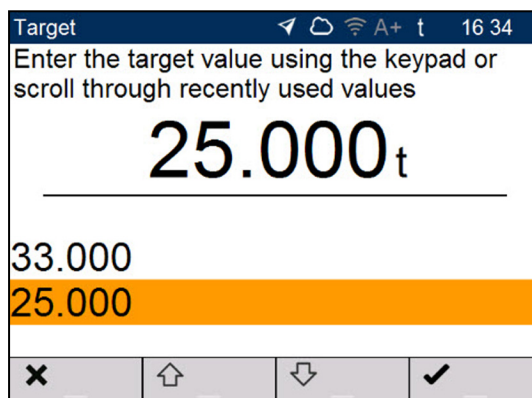

3. Add the required amount of product to the trailer. As each bucketload is lifted, the bucket weight, current trailer weight and total trailer weight will display. Between each lift, the *Split Mode* screen will display showing the new total and number of buckets lifted.
4. If you would like to split the load to another trailer, press , then go to step 3. Otherwise, continue to step 5.
5. When all trailers have been filled, press  to clear the totals.

6.2 Using *Split Weighing* mode within *Target Weighing* mode

1. In *Total* mode, load the truck with the required amount or product.
2. When the required amount of product for the truck is reached, press .
The *Total* screen will display in *Split Weighing* mode. The grand total of the entire vehicle is shown, along with the short total for the trailer.
3. Press .
The *Target* screen will display.







4. Use the keypad to enter the target weight value for the trailer, or use  and  to select a previous target weight value, if available.
5. Press .
The *Total* screen will display in *Target Weighing* mode for the trailer.
6. Raise a bucketload of product smoothly past the Weighing Zone using constant engine revs.
The message **Weighing** will display.
7. When the bucketload has been weighed, the Indicator will beep the Blue light will illuminate and the *Live Weight* screen will display the following:
 - the target weight,
 - the current bucketload,
 - the new target weight, if the bucketload is added to the truck.
8. Press  to add the bucketload to the trailer.
9. Empty the bucketload in to the trailer.
10. Repeat steps 3-8 until the target weight is as close to **0** (zero) as possible.
11. Repeat this procedure from step 2 for each additional trailer.

7.0 Main Menu

The *Main Menu* options that are available depend on options enabled at installation.

The *Main Menu* provides options for configuring the LOADRITE Weighing System.

- To display the *Main Menu*, press  when the *Total* screen is displayed.
- Press  or  to scroll up or down, then press  to select an option.
- To exit the *Setup Menu*, press .

Menu Option	Description
Data List 1: Product	Allows the current product to be changed. NOTE – Product is the default title for Data List 1 , but can be customized during installation.
Data List 2: Customer	Allows the current customer to be changed. NOTE – Customer is the default title for Data List 2 , but can be customized during installation.
Data List 3: Truck	Allows the current truck to be changed. NOTE – Truck is the default title for Data List 3 , but can be customized during installation.
Data Lists 4 to 9	Allows the values for Data Lists 4 to Data List 9 to be changed.
History	Displays the ticket transaction history and allow tickets to be searched for, displayed on-screen, and printed.
Scale	Allows the current scale (attachment) to be changed, if more than one scale has been configured at installation.
Clear All	Clears all current totals.
Reprint	Reprints the most recent ticket.
Metrics	View operator metrics and data list totals.
Preferences	Displays the <i>Preferences</i> menu for customizing various features.
About	Displays Indicator hardware, software and network specifications.
Setup...	Displays the <i>Installer Menu</i> , or other special menus, after entering an access code. <ul style="list-style-type: none"> ■ For further information, contact your LOADRITE dealer.

7.1 Product (Data List 1)



The Product option is only available if enabled at installation.

NOTE – Product is the default title for **Data List 1**, but can be customized during installation.

The *Product* screen is used to select a product to record against loads.

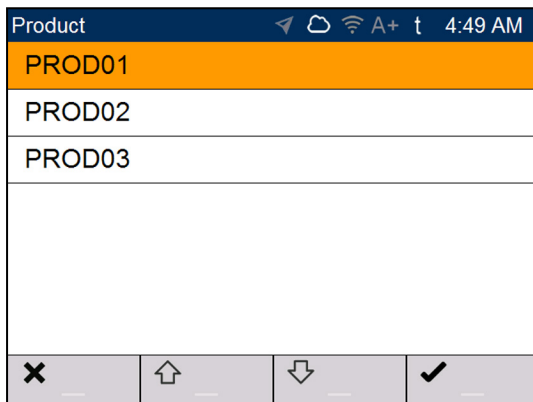

1. Press  or  to select a product.

2. Press .

The Indicator will beep and the *Main Menu* will display. All bucketloads will be recorded as the selected Product until a different Product is selected.

NOTE – If your Indicator is configured to use *Data Prompt* functionality, then after selecting an item, you will be prompted to also select from all other Data Lists that follow.

TIP – Depending on the workflow that has been selected at installation, each product may have its own short total, and changing the product will also change the short total that is displayed on the *Total* screen.



7.2 Customer (Data List 2)



The Customer option is only available if enabled at installation.

NOTE – Customer is the default title for **Data List 2**, but can be customized during installation.

The *Customer* screen is used to select a customer to record against loads.

1. Press  or  to select a customer.
2. Press .
The Indicator will beep and the *Main Menu* will display. All bucketloads will be assigned to the selected customer until a different customer is selected.

NOTE – If your Indicator is configured to use *Data Prompt* functionality, then after selecting an item, you will be prompted to also select from all other Data Lists that follow.



7.3 Truck (Data List 3)



The Truck option is only available if enabled at installation.

NOTE – Truck is the default title for **Data List 3**, but can be customized during installation.

The *Truck* screen is used to select a truck to record against loads.

1. Press  or  to select a truck.
2. Press .
The Indicator will beep and the *Main Menu* will display. All bucketloads will be assigned to the selected truck until a different truck is selected.

NOTE – If your Indicator is configured to use *Data Prompt* functionality, then after selecting an item, you will be prompted to also select from all other Data Lists that follow.

7.4 Data List 4 to Data List 9



These options are only available if enabled at installation.

Values for Data List 4 to Data List 9 can be selected in the same way as for Data List 1 to Data List 3.

- Refer to the procedure in *Product (Data List 1)* on page 34.

7.5 History



The *History* screen displays a list of all tickets for the selected date. Individual tickets may be searched for by ticket number, displayed on-screen, or printed to a connected printer. Ticket information is stored on the Indicator for up to 90 days.

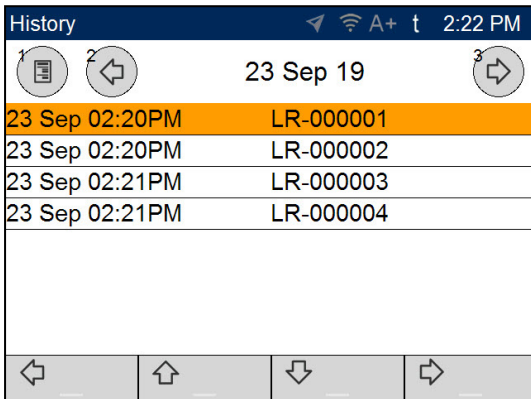





- Press or to scroll through the list of tickets for the day.
- Press or to display a list of tickets from the next or previous day.
- Press or to display the selected ticket on-screen.

7.5.1 Search for a ticket

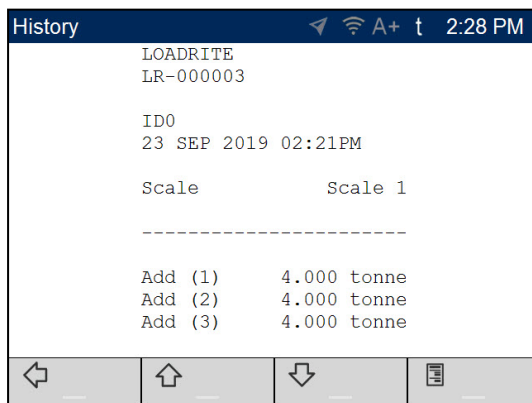
To search for a ticket by ticket number, complete the following:

- From the *History* screen, press or 1. The *Ticket Number* screen will display.
- Use the keypad to enter the ticket number of the ticket that you would like to view, then press . The ticket will display on-screen.





- Press  or  to scroll through the ticket.
- Press  to print the ticket to the connected printer.

7.5.2 Print a ticket

To print a ticket, complete the following:

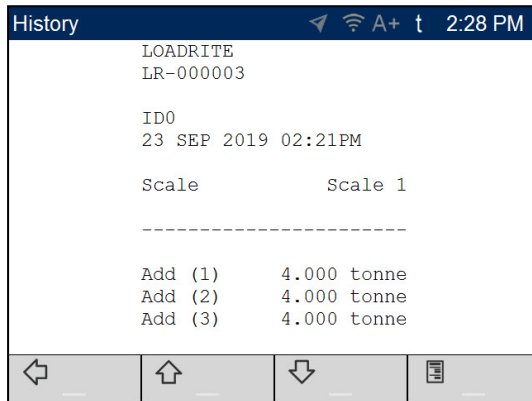
1. Display a ticket on-screen by selecting the ticket from the *History* screen, or searching for a ticket.



2. Press .
The ticket will be printed to the connected printer.

7.6 Scale



The Scale option is only available if multiple scales have been configured at installation.

The *Scale* screen is used to select the correct loading attachment, to ensure that the lifted weight is accurate.

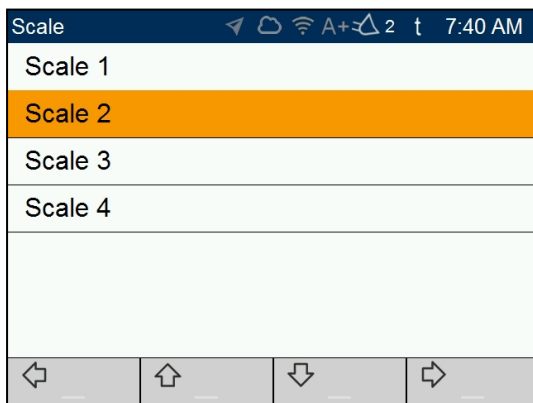

1. Press  or  to select a scale.

2. Press .

The *Main Menu* will display. All bucketloads will be recorded against the selected scale until a different scale is selected.

7.7 Reprint



The *Reprint* option is only available if a printer is connected and a ticket has been printed.



Tap or select **Reprint** to reprint the most recent ticket. The ticket can be reprinted as many times as needed, until the next time the short total is cleared and a ticket is printed, or the Indicator is turned off.

7.8 Clear All



The *Clear All* option is only available if there is more than one running total.

Tap or select **Clear All** to clear all running totals.

TIP – You can also clear all running totals from the *Product Data Lists* screen, by pressing and holding . If there is only one running total, then you can clear it from the Total screen by pressing .

7.9 Metrics



The *Metrics* menu allows you to view operator metrics, accumulated product totals, and data list totals, since they were last reset.

7.9.1 Operator Metrics



The *Operator Metrics* screen displays your KPI metrics since they were last reset.

Item	Description
Total	The total weight of all bucketloads added.
Avg. weight/hr	The average weight lifted per hour.
Load count	The number of truckloads successfully added.
First load time	The time that the first bucketload was added

Item	Description
Last load time	The time that the last bucketload was added.
Last Bucket Weight	The weight of the last bucketload added.

7.9.2 Totals



The *Totals* screens display the total amount of each product weighed and each enabled data list since they were last reset.

- Press  to scroll through each screen.

Item	Description
Total Loaded	The total weight of all bucketloads added.
Loaded Since	The date and time that the first bucketload was added.
Last load time	The date and time that the last bucketload was added.
Products	Each product loaded with the total weight and total time taken to load.

7.9.3 Reset Metrics

To reset *both* the operator metrics and loadout totals, press  from either the *Operator Metrics* screen or *Totals* screen. If a printer is connected and enabled, a ticket will be printed listing all of the loader's loadout activity since the metrics were last reset.

NOTE – When reset, all metrics data is deleted from the Indicator and cannot be recovered.

7.10 Preferences



> *Preferences*

The *Preferences* menu allows you to customize various functionality.

7.10.1 Auto-Add



> *Preferences > Auto-Add*

Controls whether *Auto-Add* functionality is enabled or disabled. If enabled, you do not have to press  after each bucketload has been weighed.

- For information on *Auto-Add*, refer to "*What is Auto-Add?*" on page 21.

Available options

Option	Description
On	<i>Auto-Add</i> is enabled, so the Indicator will automatically add each bucketload to the total.
Off	<i>Auto-Add</i> is disabled, so  must be pressed after each bucketload has been weighed.

7.10.2 Data Suspend



> *Preferences > Data Suspend*

The *Data Suspend* functionality is only available if enabled at installation.

Data Suspend is a feature that allows you to temporarily suspend associating data list values with bucketloads, sending the values to InsightHQ, and printing data list values on tickets.





Available options

Option	Description
On	<i>Data Suspend</i> is enabled, so no data is associated with each bucketload.
Off	<i>Data Suspend</i> is disabled, so data is associated with each bucketload and sent to InsightHQ.

7.10.3 Data List Display

 > *Preferences > Data List Display*

Data List Display allows you to customize the data list, metric and scale information displayed in the four (4) **Data List Display** fields of the *Total* screen. The **Data List Display** section can display up to four (4) pieces of information, specified from left to right (L-R) as **Data List Display 1** to **Data List Display 4**.

1. Press  or  to select a **Data List Display** field to configure, then press .
2. Press  or  to select the type of information to display in the selected **Data List Display** field:



Option	Description	Default for Field
Data List 1: Product	Displays the currently selected product. NOTE – Product is the default title for Data List 1 , but can be customized during installation.	Data Field 1
Data List 2: Customer	Displays the currently selected customer. NOTE – Customer is the default title for Data List 2 , but can be customized during installation.	
Data List 3: Truck	Displays the currently selected truck. NOTE – Truck is the default title for Data List 3 , but can be customized during installation.	
Data Lists 4 to 9	Displays the currently selected value for the Data List.	
Total	Displays the total weight of all bucketloads added today.	
Avg. weight/hr	Displays the average weight lifted per hour for today.	Data Field 2
Load count	Displays the number of bucketloads successfully added today.	Data Field 3
Previous Bucket Weight	Displays the weight of the last bucketload to be successfully added.	Data Field 4
Scale	Displays the currently selected scale.	
None	The Data Field does not display any information.	

3. Press . The *Data List Display* screen will display and the **Data List Display** field will now display the selected information on the *Total* screen.

7.10.4 Brightness

  > *Preferences > Brightness*

The *Brightness* screen is used to adjust the brightness level of both the touchscreen and the keypad.

- Either use the keypad, or press  or , to select your preferred brightness level from **1** (dimkest) to **5** (brightest), then press .

7.10.5 Remote Buttons

 *Preferences > Remote Buttons*

Remote buttons can be assigned different actions during installation, such as adding a bucketload, clearing the total, or zeroing the Indicator. The *Remote Buttons* screen lists all connected remote buttons and the action that will be performed when pressed.

- For more information on remote buttons, see "*Remote Buttons*" on page 21.

7.10.6 Enable Beeper

  > *Preferences > Enable Beeper*

The *Enable Beeper* function allows you to turn the Indicator audio "beeps" **On** or **Off**.

Available options

Option	Description
On	The Indicatorbeeper is enabled.
Off	The Indicatorbeeper is disabled.

7.10.7 Date and Time

➤  > Preferences > Date and Time

The *Date and Time* functionality is only available if enabled at installation.



The *Date and Time* functionality is used to set the date, time and time format used on the Indicator. It does not alter the time and date format on printed tickets.

7.10.7.1 Set the date and time

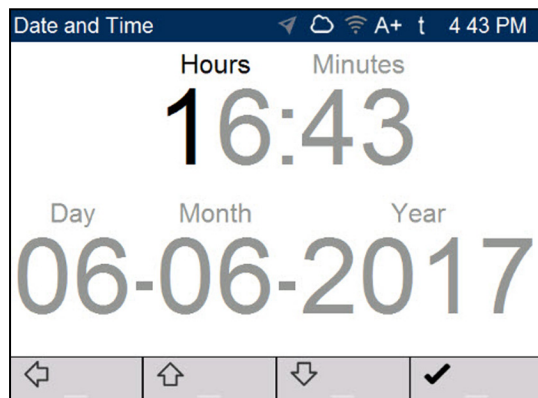
➤  > Preferences > Date and Time > Edit Date and Time



Complete the following to set the time and date:

- Use the keypad to type the **Hours**, **Minutes**, **Day**, **Month** and **Year**, one digit at a time. The cursor will move to the next digit after each key is pressed.
- Press  or  to move the cursor between the time and date.
- When the time and date are correct, press  to return to the *Date and Time* screen.

7.10.7.2 Change the time format

➤  > Preferences > Date and Time > 24-Hour Time

Controls whether the clock in the **Notification Bar**, the *Standby* screen, and printed tickets display the time in 12-hour format or 24-hour format.

Available options



Option	Description
On	The time is displayed in 24-hour format, for example 13:06 .
Off	The time is displayed in 12-hour format, for example 1:06 PM .

7.10.8 Language

➤  > *Preferences* > *Language*

Language functionality is only available if enabled at installation

The LOADRITE Indicator supports multiple languages, depending on your region. The *Language* screen is used to select the language to be used on-screen and on printed tickets.

- Press  or  to select the preferred language, then press .

7.11 About

➤  > *About*

Displays system information about the LOADRITE Indicator, including hardware, software and network specifications.

7.12 Setup...

Displays the *Security Code* screen for entering an access code. The *Installer Menu* and a range of other menus can be accessed, depending on the access code that is entered.

- For further information, contact your LOADRITE dealer.

8.0 Appendix A: System specifications

8.1 Weighing accuracy

Typical accuracy is within \pm for most bucket loaders. This may vary with different machine types, installation options, and the operating environment.

8.2 Minimal weighing delay

Weighing delay is minimal, because the weighing function is carried out during a normal lift.

8.3 Power requirements

Supply voltage	12V or 24V DC vehicular supply.
Supply current	LOADRITE Indicator: 700mA at 12V; 20mA standby; 1A maximum. LOADRITE LP950 Printer: 50mA standby, 4A peak.
Transient withstand	ISO 7637-2 and ISO 16750-2.
Transient generation	37A for 800 μ s peak current.
Power supply protection	Protected from reverse connection, transient over-voltage and load dump in accordance with ISO 7637-2 and ISO 16750-2

8.4 Physical specifications

LCD display	5.7" backlit TFT screen with 5-wire resistive-touch capability; 640x480 pixels (VGA).
Keypad	19 off tact switches with backlit silicone membrane.
Standby button	Carbon-pill power button with red/green illumination.
LEDs	Green and blue application-defined LEDs.
Temperature sensor	Internal temperature sensor -40°F to 185°F (-40°C to 85°C).
Weight	2.87lb (1.3kg) without bracket.
Dimensions	W6.5 x H10.6 x D3.2 inches (W166 x H270 x D81mm).

8.5 Environmental specifications

Operating temperature	-10°C to 50°C (14°F to 122°F).
Storage temperature	-50°C to 100°C (-58°F to 212°F).
Ingress protection	<ul style="list-style-type: none"> ■ Indicator: IP54. ■ Sensors: IP69K (water-jet cleaner).
Chemical resistance	ISO 16750-5

8.6 Electrical specifications

Sensor power output	Regulated, boosted 12.5V supply, short circuit current limited to 1A continuous and peak.
Pressure interface	12.5V supply; CAN signal; protected up to $\pm 24V$.
Pressure transducers	Two off share a 12.5V supply; 4mA - 20mA; protected up to $\pm 24V$.
Angle sensors	9~30V supply; CAN signal; protected up to 36V.
Digital I/O	Three off bi-directional ports pull-up to 12.5V with open collector outputs; protected up to $\pm 24V$ at up to 200mA each.
Ignition switch input	Input only, pull down to 0V; protected up to $\pm 24V$.
USB communications	Two USB2.0 High-speed ports share one 500mA supply; protected from 0V to +5V; ports have ingress-protection bungs.
Ethernet communications	10/100 BASE-T, IEEE 802.3 Ethernet port; RJ45 8P8C modular connector; ingress-protection bung.
Printer communications	LP950 printer via COM2: L3180-LP950 communication protocol, via adaptor cable.
Buzzer	2.8kHz \pm 500Hz 80dBA at 1m; 2.6kHz to 3kHz 70dBA at 1m.
Clock	CR2032 battery-backed real-time clock; Century, year, month, date, day, hour, minute, second, and tenths/hundredths of a second; stable to 8 seconds per day.

9.0 Appendix B: Span calibration adjustment



IMPORTANT – Legal For Trade systems: The *Span Calibration Adjustment* access code is disabled when using a Trade Approved scale, as span adjustments could invalidate the scale's certification.

This function allows small changes to be made to the LOADRITE Weighing System calibration if the bucket is modified, or if no accurate test weight was available when the LOADRITE Weighing System was calibrated at installation time.

The adjustment is carried out by entering the total weight recorded at a weighbridge (scale house) and the corresponding total provided by the LOADRITE Indicator.

To perform the adjustment, a security access code must be obtained from your LOADRITE dealer.

CAUTION – The LOADRITE Weighing System alters its calibration every time this function is used. It is important that this function is only used once with a given set of data. If the same weights are entered again, the LOADRITE Weighing System will over-correct and its accuracy will be seriously impaired.

1. Press .
2. Select **Setup...**, then press .
3. Enter the security access code provided by the LOADRITE installer, then press . The *Span Adjust* screen will display.

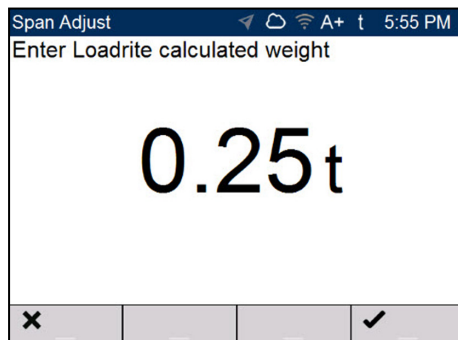

4. Enter the total weight provided by the LOADRITE Indicator, then press .

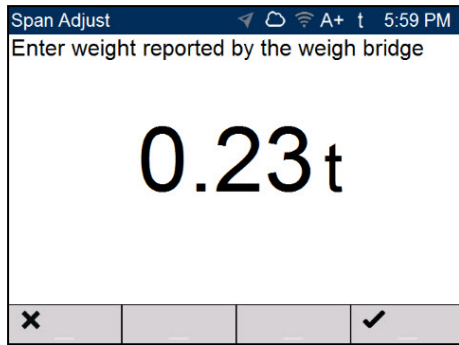

5. Enter the total weight provided by the weighbridge, then press . The LOADRITE Indicator briefly displays the **Calibration Saved** message, then returns to the *Main Menu*.

9.1 Checking the adjustment

The *Span Calibration Adjustment* can be checked by obtaining and comparing new LOADRITE and weighbridge values. If necessary, the *Span Calibration Adjustment* can be performed again using the new data.

NOTE – All trucks and trailers should have tare weights confirmed for all loads to be checked. This ensures that a true weight can be established. Avoid split-weighing the truck and trailer.

10.0 Appendix C: Legal information

Disclaimer

Trimble Inc operates a policy of on-going development. Please note that while every effort has been made to ensure that the data given in this document is accurate, due to continued product development, the information, figures, illustrations, tables, specifications, and schematics contained herein are subject to change without notice. Trimble Inc does not warrant that this document is error-free. The screenshots and other presentations shown in this manual may differ from the actual screens and presentations generated by the actual product. All such differences are minor and the actual product will deliver the described functionality as presented in this document in all material respects. If you find any errors in the document, please report them to us in writing.

Trimble Inc assumes no liability in connection with the use of any LOADRITE branded product.

Trimble Inc is not responsible for any radio or TV interference caused by unauthorized modifications to this equipment. Such modifications could void the user's authority to operate the equipment.

Compliance

Domain	Policy	Description	Top-Level Requirement
Australia / New Zealand	Radiocommunications (EMC Standards) Notice 2004 No. 2	Emissions (automotive ESA)	ISO 13766-1
Canada	ICES-003	Emissions (industrial)	ANSI C63.4
Europe	Electromagnetic Compatibility Directive 2014/30/EU	Emissions (industrial)	EN 61000-6-4
		Immunity (industrial)	EN 61000-6-4
	Restriction of Hazardous Substances Directive 2011/65/EU (RoHS 2)	Hazardous Substances	
United States of America	FCC Part 15 Subpart B - Radio Frequency Devices	Unintentional Emission (industrial)	15.107(b) and 15.109(b)



This LOADRITE product is fully EMC (Electro-Magnetic Compatibility) compliant and is CE marked accordingly. A Declaration of Conformity, in accordance with the EMC Directive 2014/30/EU (and as amended) is available from Trimble Inc on request: info@loadritescales.com

Trimble Inc cannot be held responsible for modifications made by the User and the consequences thereof, which may alter the conformity of the product with CE marking.

Hereby, Trimble Inc declares that the L3180 devices are in compliance with the essential requirements and other relevant provisions of CE.

This LOADRITE product is explicitly excluded from the scope of EU RoHS 2 Directive 2011/65/EU in article 2, section (4), paragraphs: (d), (e), (f) and (g).

This device complies with part 15 of the FCC Rules and Industry Canada licence-exempt RSS standard(s). Operation is subject to the following two conditions: (1) This device may not cause harmful interference, and (2) this device must accept any interference received, including interference that may cause undesired operation.

This Class A digital apparatus complies with Canadian ICES-003 (A) / NMB-003 (A).



WARNING – This product contains chemicals known to the State of California to cause cancer, birth defects or other reproductive harm. This Notice is being provided in accordance with California's Proposition 65.

Disposing of LOADRITE electronic equipment

This electronic product is subject to the EU Directive 2002/96/EC for Waste Electrical and Electronic Equipment (WEEE) which requires the separate collection, treatment, recycling and environmentally-sound final disposal of waste of electrical and electronic equipment. As such, this product must not be disposed of at a municipal waste collection point.

Please refer to local regulations for directions on how to dispose of this product in an environmentally-friendly manner.



Third-party software licenses

The following third-party software libraries are included as part of the L3180 software:

Mbed TLS:

Licensed under the Apache License, Version 2.0 (the "License"); you may not use this file except in compliance with the License.

You may obtain a copy of the License at: <http://www.apache.org/licenses/LICENSE-2.0>

Unless required by applicable law or agreed to in writing, software distributed under the License is distributed on an "AS IS" BASIS, WITHOUT WARRANTIES OR CONDITIONS OF ANY KIND, either express or implied. See the License for the specific language governing permissions and limitations under the License.

msinttypes:

Copyright (c) 2006-2013 Alexander Chemeris. All rights reserved. Licensed under the BSD License:

Redistribution and use in source and binary forms, with or without modification, are permitted provided that the following conditions are met:

1. Redistributions of source code must retain the above copyright notice, this list of conditions and the following disclaimer.
2. Redistributions in binary form must reproduce the above copyright notice, this list of conditions and the following disclaimer in the documentation and/or other materials provided with the distribution.
3. Neither the name of the copyright holder nor the names of its contributors may be used to endorse or promote products derived from this software without specific prior written permission.

THIS SOFTWARE IS PROVIDED BY THE COPYRIGHT HOLDERS AND CONTRIBUTORS "AS IS" AND ANY EXPRESS OR IMPLIED WARRANTIES, INCLUDING, BUT NOT LIMITED TO, THE IMPLIED WARRANTIES OF MERCHANTABILITY AND FITNESS FOR A PARTICULAR PURPOSE ARE DISCLAIMED. IN NO EVENT SHALL THE COPYRIGHT HOLDER OR CONTRIBUTORS BE LIABLE FOR ANY DIRECT, INDIRECT, INCIDENTAL, SPECIAL, EXEMPLARY, OR CONSEQUENTIAL DAMAGES (INCLUDING, BUT NOT LIMITED TO, PROCUREMENT OF SUBSTITUTE GOODS OR SERVICES; LOSS OF USE, DATA, OR PROFITS; OR BUSINESS INTERRUPTION) HOWEVER CAUSED AND ON ANY THEORY OF LIABILITY, WHETHER IN CONTRACT, STRICT LIABILITY, OR TORT (INCLUDING NEGLIGENCE OR OTHERWISE) ARISING IN ANY WAY OUT OF THE USE OF THIS SOFTWARE, EVEN IF ADVISED OF THE POSSIBILITY OF SUCH DAMAGE.

Eclipse Paho MQTT C/C++ client for Embedded platforms:

Licensed under the Eclipse Public License 1.0 (EPL 1.0). You may obtain a copy of the License at: <https://eclipse.org/org/documents/epl-v10.php>

The modified source code is available at: ftp://ftp.trimble.com/pub/open_source/

RapidJSON:

Copyright (C) 2015 THL A29 Limited, a Tencent company, and Milo Yip. All rights reserved. Licensed under the MIT License.

